

Cryptography:

Information **confidentiality, integrity, authenticity, person identification**

Symmetric Cryptography Secret Key Cryptography

Asymmetric Cryptography Public Key Cryptography

Symmetric encryption
H-functions, Message digest
HMAC H-Message Authentication Code

Asymmetric encryption
E-signature - Public Key Infrastructure - PKI
E-money, Blockchain
E-voting
Digital Rights Management - DRM (Marlin)
Etc.

Symmetric - Secret Key Encryption - Decryption

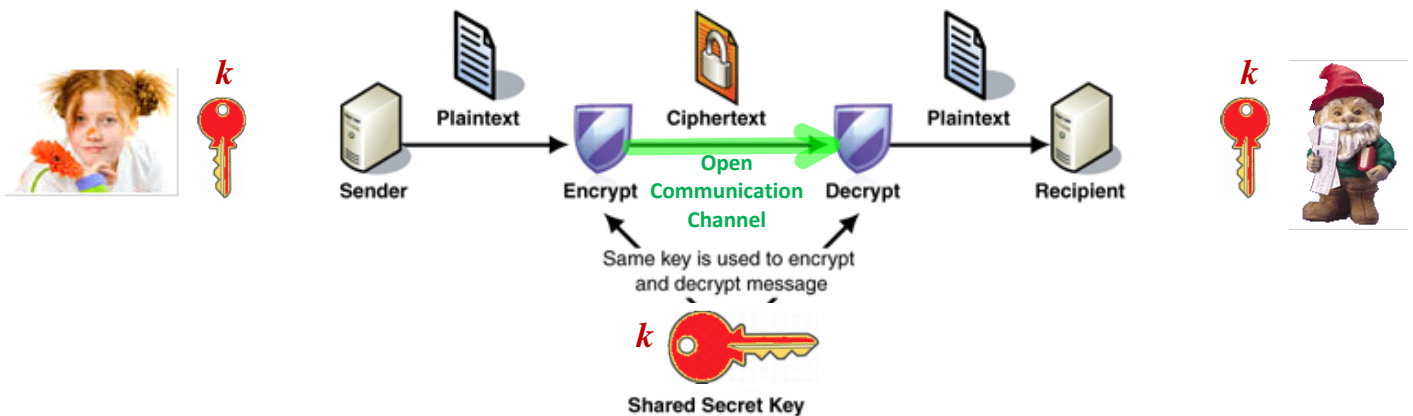

Imagine that number of users of cryptosystem is 100.

$$C_{100}^2 = \frac{100 \cdot 99}{2} = 4950$$

Symmetric ciphers

Block Ciphers
AES-128, 192, 256
Advanced Encryption Standard

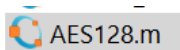

Stream Ciphers
Vernam cipher: based on binary XOR operation

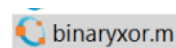

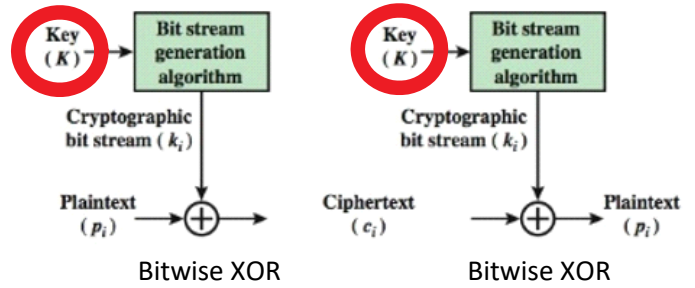
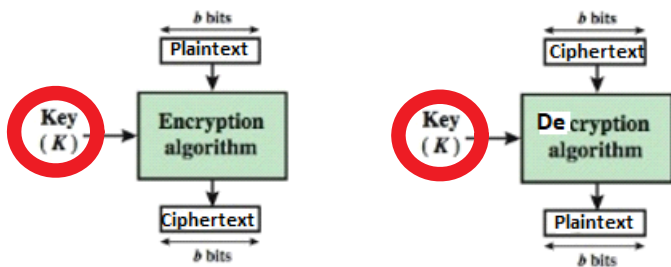

2^{64} bits with required randomness properties

Vernam cipher (1917) - One Time Pad

Logical operations

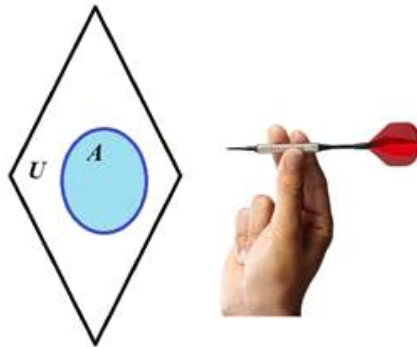

$A \cup B$

$A \cap B$

$A \oplus B$

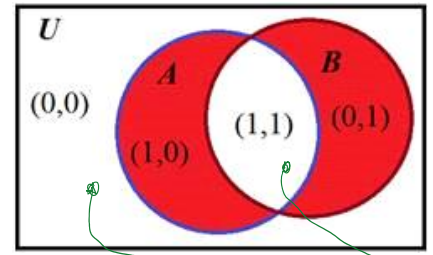
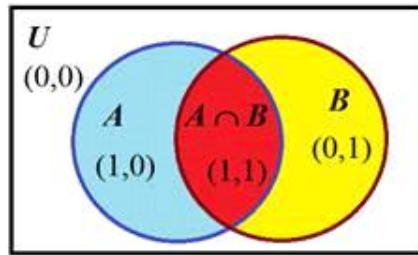
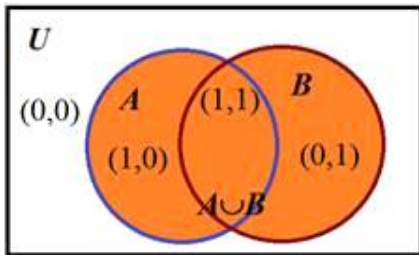

"0" No

"1" Yes

$m \in \{0,1\}$

$k \leftarrow \text{rand} \{0,1\} ; k \in \{0,1\}$

$c = m \oplus k$

\xrightarrow{c}
if $c = 0$
if $c = 1$

A	B	$A \oplus B$
0	0	0
0	1	1
1	0	1
1	1	0

m	k	$m \oplus k = c$
0	0	0
0	1	1
1	0	1
1	1	0

\oplus - is inverse to itself

1/2

$c = m \oplus k - k = m$

$c = m \oplus k \oplus k = m$

\oplus - is inverse to itself

$1/2$

$$c = m \oplus \cancel{k} - \cancel{k} = m$$

$$c = m \oplus \cancel{k} \oplus \cancel{k} =$$

$$= m \oplus 0 = m = 1$$

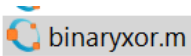

Requirements:

1. Key k must be generated at random and uniformly. standard FIPS - 140-2.
2. Key k must have the same length as plaintext m .
3. Key k must be used only once.

Let $m_1 \in \{0,1\}^N$, $k \in \{0,1\}^N$; $m_2 \in \{0,1\}^N \rightarrow m_2 = 1$

$$c_1 = m_1 \oplus k$$

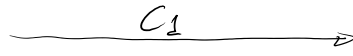

$$m_1 = c_1 \oplus k$$

$$c_2 = m_2 \oplus k$$

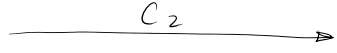

$$m_2 = c_2 \oplus k$$

So: gets c_1, c_2

$$1. c_1 \oplus c_2 = m_1 \oplus \cancel{k} \oplus m_2 \oplus \cancel{k} = m_1 \oplus m_2 = m_1 \oplus 1$$

$$2. c_1 \oplus c_2 \oplus m_2 = c_1 \oplus c_2 \oplus 1 = m_1 \oplus 1 \oplus 1 = m_1 \oplus 0 = m_1$$

Encryption of multiple bits:

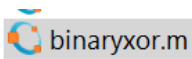

Decryption - " -

									$b_3 b_2 b_1 b_0$
$m:$	\oplus	1001	1011	0110					
$k:$		0101	1001	0011					
$c:$		1100	0010	0101					
$k:$	\oplus	0101	1001	0011					
$m:$		1001	1011	0110					

Block cipher AES - 128, 192, 256 --> Encryption --> Decryption

Advanced Encryption Standard ~ 2000

Key length 128, 192, 256 bits: $k \in \{128b, 192b, 256b\}$

$$2^{128/2} = 2^{127}$$

$$2^{191}$$

$$2^{255} \approx 10^{700}$$

Public Key Cryptography - PKC

Principles of Public Key Cryptography

Instead of using single symmetric key shared in advance by the parties for realization of symmetric cryptography, asymmetric cryptography uses two *mathematically* related keys named as private key and public key we denote by **PrK** and **PuK** respectively.

PrK is a secret key owned *personally* by every user of cryptosystem and must be kept secretly. Due to the great importance of **PrK** secrecy for information security we labeled it in **red** color. **PuK** is a non-secret *personal* key and it is known for every user of cryptosystem and therefore we labeled it by **green** color. The loss of **PrK** causes a dramatic consequences comparable with those as losing password or pin code. This means that cryptographic identity of the user is lost. Then, for example, if user has no copy of **PrK** he get no access to his bank account. Moreover his cryptocurrencies are lost forever. If **PrK** is got into the wrong hands, e.g. into adversary hands, then it reveals a way to impersonate the user. Since user's **PuK** is known for everybody then adversary knows his key pair (**PrK**, **PuK**) and can forge his Digital Signature, decrypt messages, get access to the data available to the user (bank account or cryptocurrency account) and etc.

Let function relating key pair (**PrK**, **PuK**) be F . Then in most cases of our study (if not declared opposite) this relation is expressed in the following way:

$$\mathbf{PuK} = F(\mathbf{PrK}).$$

In open cryptography according to **Kerchhoff principle** function F must be known to all users of cryptosystem while security is achieved by secrecy of cryptographic keys. To be more precise to compute **PuK** using function F it must be defined using some parameters named as public parameters we denote by **PP** and color in blue that should be defined at the first step of cryptosystem creation. Since we will start from the cryptosystems based on discrete exponent function then these public parameters are

$$\mathbf{PP} = (p, g).$$

Notice that relation represents very important cause and consequence relation we name as the direct relation: when given **PrK** we compute **PuK**.

Let us imagine that for given F we can find the inverse relation to compute **PrK** when **PuK** is given. Abstractly this relation can be represented by the inverse function F^{-1} . Then

$$\mathbf{PrK} = F^{-1}(\mathbf{PuK}).$$

In this case the secrecy of **PrK** is lost with all negative consequences above. To avoid these undesirable consequences function F must be **one-way function** – OWF. In this case informally OWF is defined in the following way:

1. The computation of its direct value **PuK** when **PrK** and F in are given is effective.
2. The computation of its inverse value **PrK** when **PuK** and F are given is infeasible, meaning that to find F^{-1} is infeasible.

The one-wayness of F allow us to relate person with his/her **PrK** through the **PuK**. If F is 1-to-1, then the pair (**PrK**, **PuK**) is unique. So **PrK** could be reckoned as a unique secret parameter associated with certain person. This person can declare the possession or **PrK** by sharing his/her **PuK** as his public parameter related with **PrK** and and at the same time not revealing **PrK**.

So, every user in asymmetric cryptography possesses key pair (**PrK**, **PuK**). Therefore, cryptosystems based on asymmetric cryptography are named as **Public Key CryptoSystems** (PKCS).

We will consider the same two traditional (canonical) actors in our study, namely Alice and Bob.

Everybody is having the corresponding key pair (**PrK_A**, **PuK_A**) and (**PrK_B**, **PuK_B**) and are exchanging with their public keys using open communication channel as indicated in figure below.

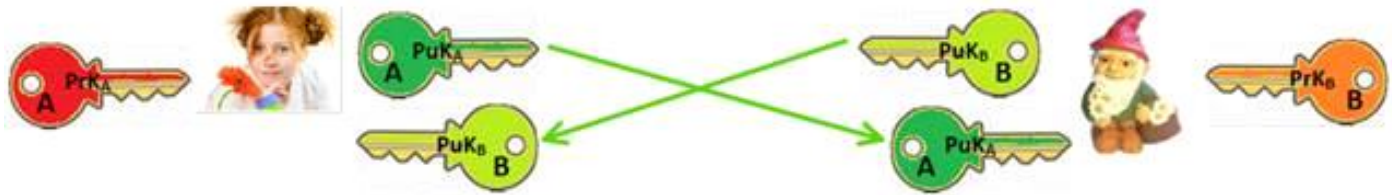

<https://imimsociety.net/en/14-cryptography>

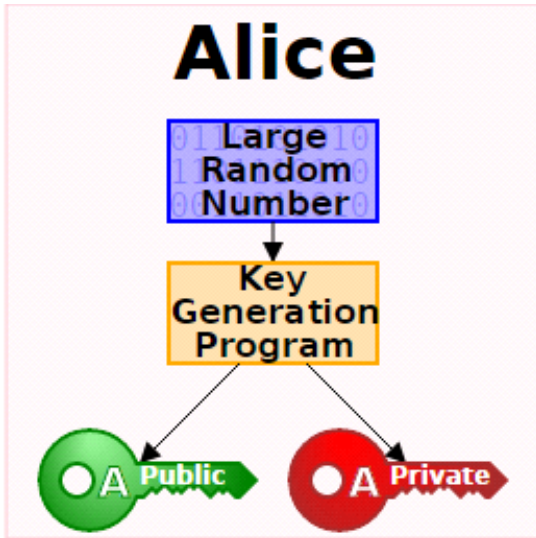

PrK and **PuK** are related

$$\mathbf{PuK} = \mathbf{F}(\mathbf{PrK})$$

F is one-way function - OWF:

It is easy to compute **PuK** when **F** and **PrK** are given.

Kerchoff principle.

Having **PuK** and **F**, it is infeasible to find $\mathbf{PrK} = \mathbf{F}^{-1}(\mathbf{PuK})$.

Public Parameters PP = (p, g)

$$p \sim 2^{2048} \approx 10^{760}; \quad |p| = 2048 \text{ b.}$$

= 760 dec. digits

We will use $|p| = 28$ bits.

To generate **PrK** and **PuK** we need to generate $\mathbf{PP} = (p, g)$

$$\mathbf{PrK} = x \leftarrow \text{randi} \implies \mathbf{PuK} = a = g^x \text{ mod } p$$

Open SSL software
Python
Go

$$|\mathbf{PrK}| = 2048 \text{ bits}$$

$$|\mathbf{PuK}| = 2048 \text{ bits}$$

$$[1, 2^{2048}]$$

Till this place

Asymmetric Encryption - Decryption

$$c = \text{Enc}(\text{PuK}_A, m)$$

$$m = \text{Dec}(\text{PrK}_A, c)$$

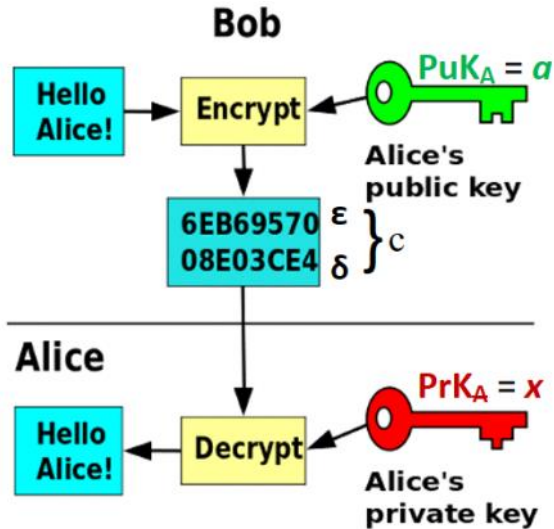

Asymmetric Signing - Verification

$$\text{Sign}(\text{PrK}_A, m) = \sigma = (r, s)$$

$$V = \text{Ver}(\text{PuK}_A, m, s), V \in \{\text{True}, \text{False}\} \equiv \{1, 0\}$$

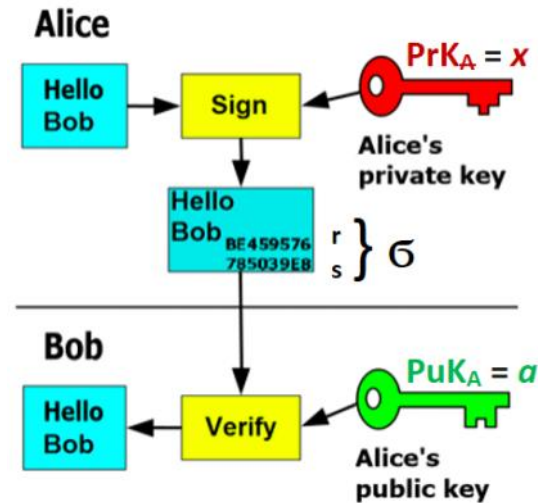

1. Identification.

If person can prove that he/she knows **PrK** corresponding to his/her **PuK** without revealing any information about **PrK** then everybody can trust that he is communicating with person possessing (**PrK**, **PuK**) key pair. This kind of proof is named as **Zero Knowledge Proof (ZKP)** and plays a very important role in cryptography. It is very useful to realize identification, Digital Signatures and many other cryptographically secure protocols in internet. In many cryptographic protocols, especially in identification protocols **PrK** is named as **witness** and **PuK** as a **statement** for **PrK**.

Every actor is having the corresponding key pair (**PrK_A**, **PuK_A**) and all **PuK** are exchanged between the users using open communication channel as indicated in figure below.

Let Bob is sure that **PuK_A** is of Alice and wants to tell Alice that he intends to send her his photo with chamomile flowers dedicated for Alice. But he wants to be sure that he is communicating only with Alice itself and with nobody else. He hopes that at first Alice will prove him that she knows her secret **PrK_A** using ZKP protocol. In general, this protocol is named as identification protocol, it is interactive and has 3 communications to exchange the following data named as **commitment**, **challenge** and **response**.

One-Way Functions